

(EN) Mounting instruction

(DK) Monteringsvejledning

(DE) Montageanleitung

(FR) Notice de montage

(NL) Montage-voorschrift

(SV) Monteringsanvisning

(NO) Monteringsveiledning

(ES) Instrucciones de montaje

Subject to alteration without further notice. Ret til ændringer forbeholdes. · Recht auf Änderungen sind vorbehalten. · Nous nous réservons le droit d'apporter toutes modifications sans préavis. · Wijzigingen voorbehouden. · Rätten till ändringar förbehålles. · Vi forbeholder oss rett til endringer. · Salvo variaciones.

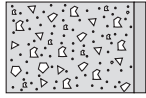

- (EN) Concrete >B25
- (DK) Beton >B25
- (DE) Beton >B25
- (FR) Mur de béton >B25
- (NL) Betonwanden >B25
- (SV) Massiv betong >B25
- (NO) Betonveg >B25
- (ES) Paredes de hormigón >B25

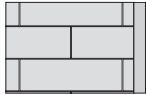
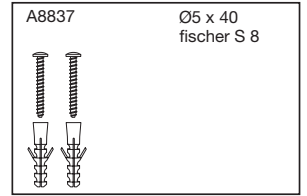

- (EN) Solid Brick >= Mz12
- (DK) Mursten >= Mz12
- (DE) Vollstein >= Mz12
- (FR) Brique pleine >= Mz12
- (NL) Gemetselde wanden >= Mz12
- (SV) Mursten >= Mz12
- (NO) Mursteinsvegger >= Mz12
- (ES) Paredes de ladrillo >= Mz12

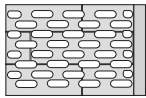
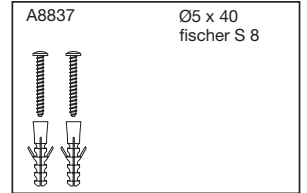

- (EN) Solid Sand Lime Brick >= Hlz12
- (DK) Kalksten >= Hlz12
- (DE) Massiver Kalksandstein >= Hlz12
- (FR) Parpaing plein >= Hlz12
- (NL) Kalksteen >= Hlz12
- (SV) Cementsten >= Hlz12
- (NO) Massiv kalksandstein >= Hlz12
- (ES) Caliza >= Hlz12

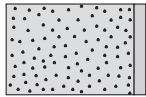
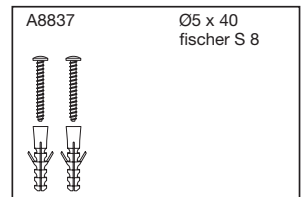

- (EN) Aerated Concrete P4
- (DK) Gasbeton P4
- (DE) Gasbeton P4
- (FR) Béton cellulaire P4
- (NL) Gasbeton P4
- (SV) Lättbetong P4
- (NO) Gassbetong P4
- (ES) Paredes de hormigón poroso P4

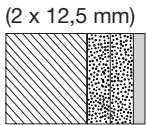
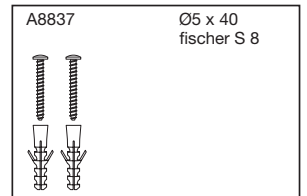

- (EN) Drywall water-resistant, re-enforced with wood
- (DK) Gipsplader vandfast, med træforstærkning
- (DE) Gipsplatten wasserfest, mit Holz
- (FR) Plaque de plâtre imperméable, renforcée de bois
- (NL) Gipsplaten, watervast, versterkt met hout
- (SV) Godkända våtrumsskivor förstärkt med trä
- (NO) Gipsplater vannfast, med rupanel
- (ES) Pared de yeso impermeable, reforzamiento de madera

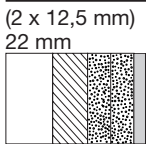
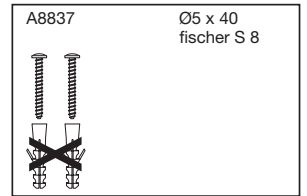

- (EN) Drywall water-resistant, re-enforced with plywood
- (DK) Gipsplader vandfast, forstærket med krydsfinér
- (DE) Gipsplatten wasserfest, versterkt mit Sperrholz
- (FR) Plaque de plâtre imperméable, renforcée de contreplaqué
- (NL) Gipsplaten, watervast, versterkt met hout
- (SV) Godkända våtrumsskivor förstärkt med kryssfanér
- (NO) Gipsplater vannfast, forsterket med kryssfinér
- (ES) Pared de yeso impermeable, reforzamiento de madera contrachapada

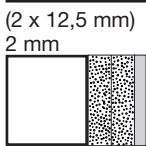
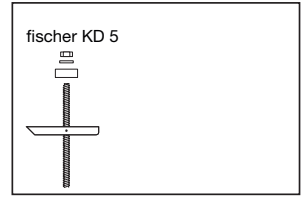

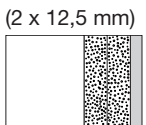
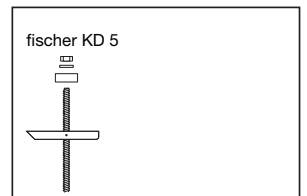

- (EN) Drywall water-resistant, re-enforced with steel plates
- (DK) Gipsplader vandfast, forstærket med stålplader
- (DE) Gipsplatten wasserfest, versterkt mit Stahlplatten
- (FR) Plaque de plâtre imperméable, renforcée d'acier
- (NL) Gipsplaten, watervast, versterkt met staal
- (SV) Godkända våtrumsskivor förstärkt med stål
- (NO) Gipsplater vannfast, forsterket med stålplater
- (ES) Pared de yeso impermeable, reforzamiento de placa de acero



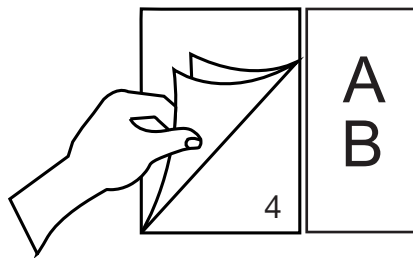
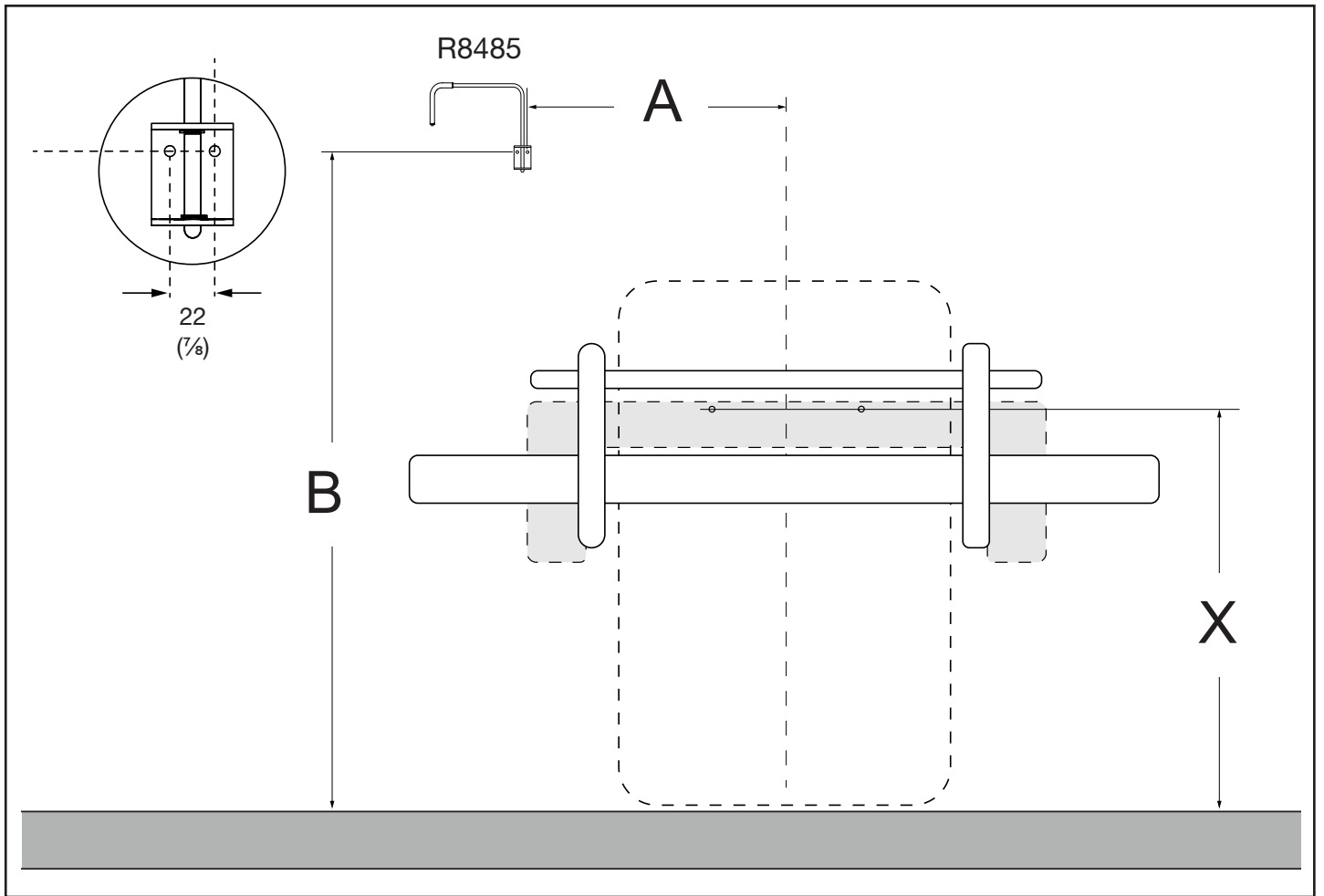

- (EN) Drywall water-resistant
- (DK) Gipsplader vandfaste
- (DE) Gipsplatten wasserfest
- (FR) Plaques de plâtre imperméables
- (NL) Gipsplaten, watervast
- (SV) Godkända våtrumsskivor
- (NO) Gipsplater vannfast
- (ES) Pared de yeso impermeable

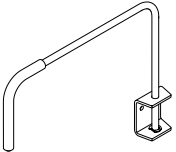

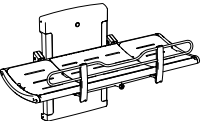
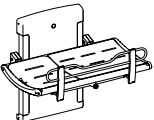
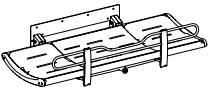
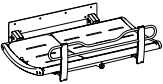
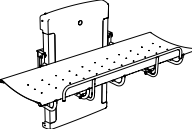
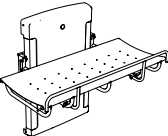
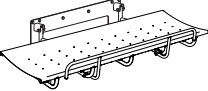
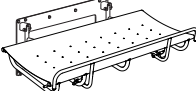
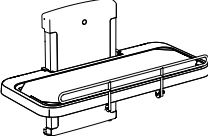

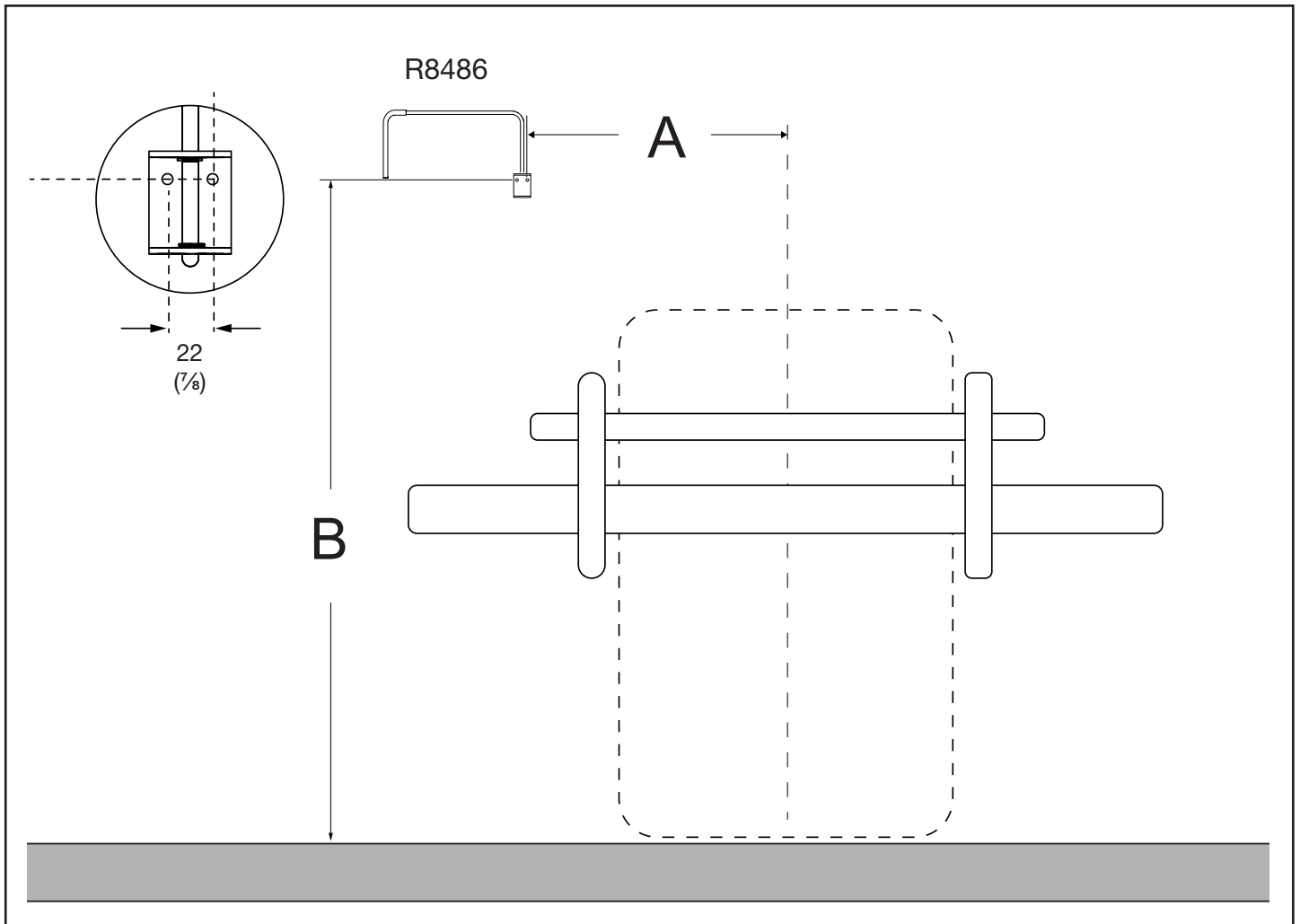
 R8485	<div style="border: 1px solid black; padding: 2px; display: inline-block;">REF</div>	A	B	
	R8572318 R8582318 R8592318	825 (32½)	1558 (61⅝)	R8572-82-92-313-318
	R8572313 R8582313 R8592313	575 (22⅝)	1558 (61⅝)	R8572-82-92-313-318
	R8435318	825 (32½)	X+600 (23⅝)	R8435-313-318
	R8435313	575 (22⅝)	X+600 (23⅝)	R8435-313-318
	R8401 R8403	640 (25⅜)	1505 (59¼)	R8400-03
	R8400 R8402	440 (17⅝)	1505 (59¼)	R8400-03
	R8407	640 (25⅜)	X+630 (24⅜)	R8406-07
	R8406	440 (17⅝)	X+630 (24⅜)	R8406-07
	R8468 R8478 R8572418 R8582418 R8592418	710 (28)	1598 (62⅜)	R8468-78 R8572-82-92-418

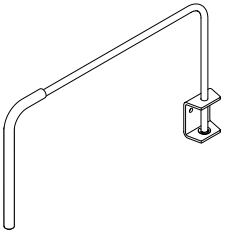

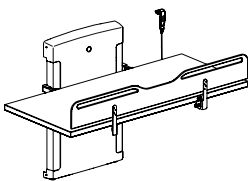
 <p>R8486</p>	<p><b>REF</b></p>	<p><b>A</b></p>	<p><b>B</b></p>	
	<p>R8574572 R8584572 R8594572</p>	<p>840 (33<math>\frac{1}{8}</math>)</p>	<p>1700 (66<math>\frac{7}{8}</math>)</p>	<p>R8574-84-94-572</p>

**(EN) Maintenance, cleaning**

Use only regular soap water (avoid cleaners which polish, corrode or contain chlorine).

**(DK) Vedligeholdelse, rengøring**

Anvend kun alm. sæbevand (undgå slibende, ætsende og klorholdige rengøringsmidler).

**(DE) Reinigungs- und Gebrauchsanleitung**

Nur normale Seifenlauge verwenden (keine schleifen- den, ätzenden oder chlorhaltigen Reinigungsmittel).

**(FR) Entretien, nettoyage**

N'utiliser que de l'eau savonneuse ordinaire (éviter les produits de nettoyage abrasifs, corrosifs et javellisés).

**(NL) Onderhoud, reiniging**

Gebruik alleen normale huishoudelijke schoonmaak- middelen (geen schurende, etsende of chloorhouden- de middelen).

**(SV) Rengöring och underhåll**

Använd endast vanligt såpvatten (undvik slipande, frätande och klorhaltiga rengöringsmedel).

**(NO) Vedlikehold, rengjøring**

Bruk bare vanlig sæpevann (unngå slibende, etsende og klorholdige rengjøringsmidler).

**(ES) Mantenimiento, limpieza**

Utilice únicamente agua y jabón neutro (evite el uso de detergentes abrillantadores, corrosivos o que con- tengan clorina).

